



Patent #6,253,416 and other patents pending
F601S
BILLY GOAT FORCE BLOWER
Owner's Manual

ACCESSORIES

FRONT AIR DIRECTOR

Simple to attach, allowing air to be directed forward.



PN# 441130



ABOUT THIS MANUAL

THANK YOU for purchasing a BILLY GOAT® *FORCE Blower*. Your new machine has been carefully designed and manufactured to provide years of reliable and productive service. This manual provides complete operating and maintenance instructions that will help to maintain your FORCE Blower in top running order. Read this manual carefully before assembling, operating, or servicing your equipment.

CONTENTS

SERIAL PLATE DATA AND SPECIFICATIONS _____	3
GENERAL SAFETY _____	4-5
SOUND AND VIBRATION _____	6
INSTRUCTION LABELS _____	7
PACKING CHECKLIST _____	8
ASSEMBLY _____	9
OPERATION _____	10-11
MAINTENANCE _____	12
TROUBLESHOOTING AND WARRANTY PROCEDURE _____	13
ILLUSTRATED PARTS LIST _____	14
PARTS LIST _____	15
MAINTENANCE RECORD _____	16





FORCE 6 BLOWER Owner's Manual

SERIAL PLATE DATA

Record the model number, serial number, date of purchase, and where purchased.

Purchase Date: _____

Purchased From: _____

			1803 S.W. Jefferson Lee's Summit, MO 64082 / USA Tel (816) 524-9666 Fax (816) 524-6983	
	Model <input type="text"/>		Serial No. <input type="text"/>	
Unit(Weight) <input type="text"/> lbs. <input type="text"/> kg		Engine Power <input type="text"/> kW <input type="text"/> rpm		

Specifications

F601S

Engine: HP	6.0 HP (4.7kW)
Engine: Model	EX17D50012
Engine: Type	SUBARU
Engine: Fuel Capacity	3.8 qt.(3.6 L)
Engine: Oil Capacity	0.63 qt.(0.60 L)
Total Unit Weight:	76# (34.5 kg)
Overall Length:	43.5"(1.1m)
Overall Width	22" (0.56m)
Overall Height	45" (1.14m)
In compliance with 2000/14/EEC standards	105dB(a) @3600 rpm
Sound at Operator's ears	89dB(a) @ 3600 rpm
Vibration at operator position	1.02 g (10.1 m/s ²)



GENERAL SAFETY INSTRUCTIONS and SYMBOLS

The safety symbols shown below are used throughout this manual. You should become familiar with them before assembling, operating, or servicing this equipment.



WARNING: This symbol indicates important information that will prevent injury to yourself or others.



This symbol indicates ear protection is recommended when operating this equipment.



This symbol indicates eye protection is recommended when operating this equipment.



This symbol indicates gloves should be worn when servicing this equipment.



This symbol indicates that this manual and the engine manufacturer's manual should be read carefully before assembling, operation, or servicing this equipment.



CAUTION: This symbol indicates important information that will prevent damage to your BILLY GOAT[®] FORCE Blower.



This symbol indicates the engine oil level should be checked before operating this equipment.

Read and make sure you thoroughly understand the following safety precautions before assembling, operating or servicing this equipment:



READ this manual and the engine manufacturer's manual carefully before assembling, operating, or servicing this equipment.



EAR PROTECTION is recommended when operating this equipment.



EYE PROTECTION is recommended when operating this equipment.



BREATHING PROTECTION is recommended when operating this equipment.



WARNING: **EXHAUST** from this product contains chemicals known to the State of California to cause cancer, birth defects or other reproductive harm.

DO NOT operate this equipment on any unimproved forested, brushy, or grass covered land unless a spark arrester is installed on the muffler as required by Section 4442 of the California Public Resources Code. The arrester must be maintained in good working order. Other states may have similar laws. Federal laws apply on federal lands.

DO NOT run engine in an enclosed area. Exhaust gases contain carbon monoxide, an odorless and possibly fatal poison.





FORCE 6 BLOWER Owner's Manual





WARNING:  **DO NOT** run this equipment indoors or in any poorly ventilated area. Refueling outdoors is recommended.

 **DO NOT** refuel this equipment while the engine is running. Allow engine to cool for at least two minutes before refueling.

 **DO NOT** store gasoline near an open flame.

 **DO NOT** remove gas cap while engine is running.

 **DO NOT** start or operate engine if strong odor of gasoline is present.

 **DO NOT** start or operate engine if gasoline is spilled. Move equipment away from spill until gasoline has completely evaporated.

 **DO NOT** smoke while filling the fuel tank.

 **DO NOT** check for spark with spark plug or spark plug wire removed. Use an approved spark tester.

 **DO NOT** operate engine without a muffler. Inspect muffler periodically and replace if necessary. If equipped with muffler deflector, inspect deflector periodically and replace if necessary.

 **DO NOT** operate engine with grass, leaves or other combustible material near the muffler.

 **DO NOT** touch muffler, cylinder, or cooling fins when hot. Contact with hot surfaces may cause severe burns.

 **DO NOT** leave equipment unattended while in operation.

 **DO NOT** park equipment on a steep grade or slope.

 **DO NOT** operate equipment with bystanders in or near the work area.

 **DO NOT** allow children to operate this equipment.

 **DO NOT** operate equipment with guards removed.

 **DO NOT** operate equipment near hot or burning debris or any toxic or explosive materials.

 **DO NOT** operate equipment on slopes greater than specified in Specifications section of this manual.

ALWAYS remove spark plug wire when servicing equipment to prevent accidental starting.

ALWAYS check fuel lines and fittings frequently for cracks or leaks. Replace if necessary.

ALWAYS keep hands and feet away from moving or rotating parts.

ALWAYS store fuel in approved safety containers.



WARNING: Important

Do not run this machine without director cone attached or with improper air director cone.



DO NOT run this machine with a cracked or damaged impeller under any circumstances.



SOUND



SOUND LEVEL 89 Db(a) at Operators Position

Sound tests were conducted in accordance with 2000/14/EC, as well as ISO 11094, and were performed on 8-3-2007 under the conditions listed below.

⚠ Sound power level listed is the highest value for any model covered in this manual. Please refer to serial plate on the unit for the sound power level for your model.

General Conditions:	Sunny
Temperature:	87.8°F (31.1°C)
Wind Speed:	1.8 mph (2.8kph)
Wind Direction:	East South east
Humidity:	61.5%
Barometric Pressure:	30.1Hg (101.98kpa)

VIBRATION DATA

VIBRATION LEVEL 1.02g (10.1m/s²)

Vibration levels at the operator's handles were measured in the vertical, lateral and longitudinal directions using calibrated vibration test equipment. Tests were performed on 9-20-07 under the conditions listed below.

General Conditions:	Sunny
Temperature:	86.5°F (30.3°C)
Wind Speed:	8 mph (13 kph)
Wind Direction:	South Southwest
Humidity:	49.8%
Barometric Pressure:	30.1Hg (101.94kpa)

INTENDED USE

This machine is designed for cleaning outdoor surfaces, where the debris can be effectively blown into a consolidated area for convenient pickup and removal.

⚠ DO NOT OPERATE IF EXCESSIVE VIBRATION OCCURS. If excessive vibration occurs, shut engine off immediately and check for damaged or worn impeller, loose impeller bolt, loose impeller key, loose engine or debris stuck in fan or housing. To remove debris from impeller see the trouble shooting section on page 13. Note: See parts list for proper impeller bolt torque specifications.



INSTRUCTION LABELS

The labels shown below were installed on your BILLY GOAT® FORCE Blower. If any labels are damaged or missing, replace them before operating this equipment. Item numbers from the Illustrated Parts List and part numbers are provided for convenience in ordering replacement labels. The correct position for each label may be determined by referring to the Figure and Item numbers shown.



LABEL READ OWNERS MANUAL
ITEM #35 P/N890301



LABEL EAR EYE BREATHING
ITEM#36 P/N890254



DANGER FLYING DEBRIS
ITEM # 37 P/N 810736



LABEL EXPLOSIVE FUEL
ITEM # 34 P/N 400268

ENGINE LABELS

SUBARU





PACKING CHECKLIST

These items should be included in your carton. If any of these parts are missing, contact your dealer.
Your BILLY GOAT® *FORCE Blower* was shipped in one carton, completely assembled except for the Upper Handle Assembly and Front Diverter. Mounting hardware for the Upper Handle Assembly can be found on the lower handle.



READ all safety instructions before assembling unit.

TAKE CAUTION when removing the unit from the box the Handle Assembly is attached to the unit by cables.



PUT OIL IN ENGINE BEFORE STARTING

PARTS BAG & LITERATURE ASSY

Warranty card P/N- 400972, Owner's Manual P/N-441161, Declaration of Conformity P/N-440022



Boxing Parts Checklist

- Handle Upper Assembly
Item #24 P/N-441157
- Parts Bag & Literature Assy
P/N-441160
- Subaru 6

ASSEMBLY

1. Follow the steps in figures A and B, then securely tighten all hardware shown.
2. Connect spark plug wire.

Figure A

The hardware for attaching the upper handle to the lower can be found on the lower handle. Install upper handle (item 24), to preassembled lower handles (item 25 & 26) by sliding the upper over and down the inside of the lower handle. Using bolt (item #12), washers (item #10) & lock nut (item #11) to install upper handle to lower handle. Finish installing the other side of the upper handle assembly using screw and lock nut provided. The Aim-and-Shoot™ is not attached, you will need to unroll the cable and attach the ball end to the lever and seat the cable end into the hole on the saddle clamp, with the cable running through the slot. To keep the cable from being damaged use three ty-wraps (item 61) to secure it to the handle as shown making sure that the cable is not rubbing against the tire.

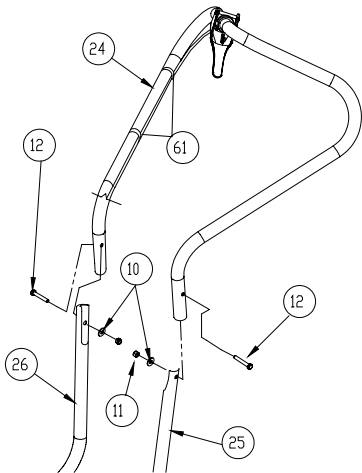

Two 1/2" open ended wrenches

Figure B

Attach the front tire using the hardware located on the front wheel bracket. Use a block to raise the front end of the unit off the ground. Insert the wheel spacer (item 17) into the wheel and place in between the bracket. Finally insert the bolt (item 20) through the bracket, wheel, and spacer and secure with the nut (item 27)

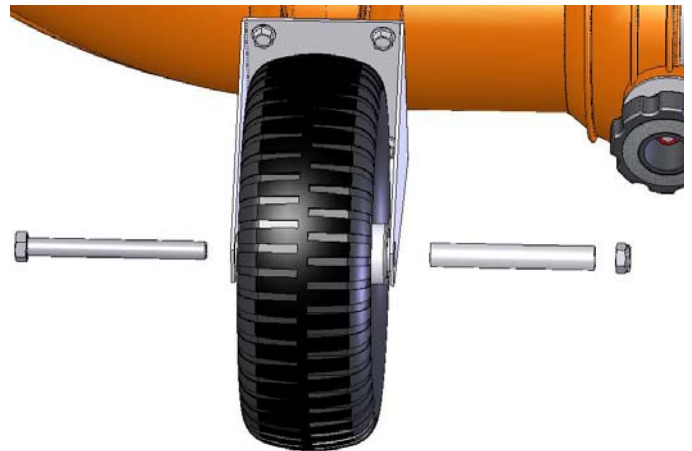

Two 9/16" Wrenches



OPERATION

 Like all mechanical tools, reasonable care must be used when operating machine.
Inspect machine work area and machine before operating. Make sure that all operators of this equipment are trained in general machine use and safety.

 **PUT OIL IN ENGINE BEFORE STARTING**

STARTING

 **ENGINE:** See engine manufacturer's instructions for type and amount of oil and gasoline used. Engine must be level when checking and filling oil and gasoline.

FUEL VALVE: Move fuel valve to "ON" position (when provided on engine).

STOP SWITCH: Located on the engine. "ON" position.

CHOKE: Operated with choke lever on engine.

THROTTLE: Controlled by throttle lever on the handle. Move remote throttle control to fast position. Pull starting rope to start engine.

ENGINE SPEED: Under normal conditions, operate at minimum throttle to accomplish your current cleaning task.

IF YOUR UNIT FAILS TO START:

See Troubleshooting on page 13.

HANDLING & TRANSPORTING:

Using two people to lift machine is recommended. Lift holding the handle and handle brace. Secure in place during transportation. See series specifications on page 3 for unit weight.

 Do not use the front grill as an anchor point when securing the unit for transport.

 Never lift the machine while the engine is running.

BLOWING OPERATION

Your Billy Goat Force blower is equipped with an air director cone and the patented Aim-N-Shoot™ control lever to allow the operator to direct the air stream up or down as required to assist in moving debris. This feature is extremely useful when debris has piled up to the point that it cannot be blown any farther. The air stream can be directed upward to blow the top of the debris pile over and allow the operator to continue moving more debris farther.



ADJUSTING AIR DIRECTOR

To adjust air direction, squeeze Aim-N-Shoot™ control lever. When you want to blow debris at the same angle for an extended period, choose a suitable position and use the finger controlled push button lock to lock the cone in position. For operations that do not require the use of the Aim-N-Shoot™ feature the manual adjustment knob, pictured below, can be used to permanently lock the cone into position. NOTE: be sure to release the knob when returning to using the Aim-N-Shoot™.

⚠ DO NOT position director cone to where it will blow debris towards people, vehicles or other objects in vicinity. Flying debris may damage, harm, or cause injury to people or objects in air flow range.

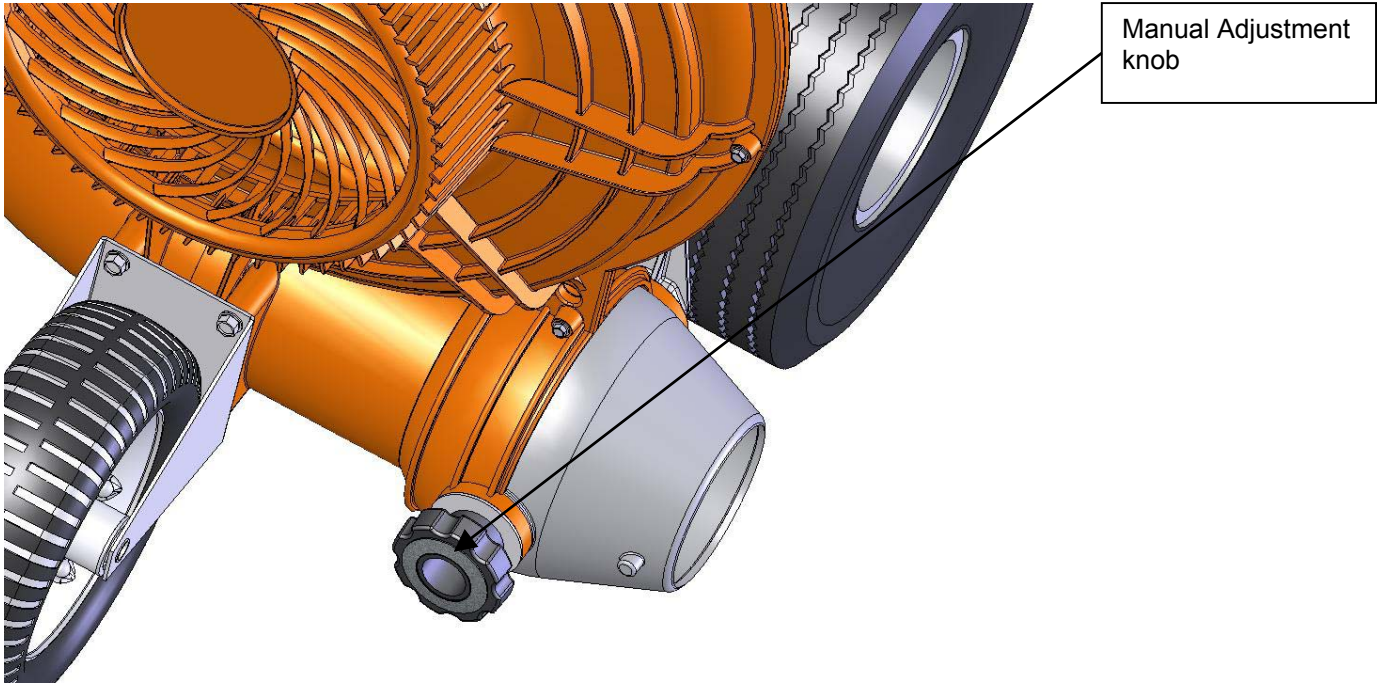



MAINTENANCE

PERIODIC MAINTENANCE

Periodic maintenance should be performed at the following intervals:

Maintenance Operation	Every Use	Daily or Every 5 Hours	Every 25 Hours	Every 50 Hours	Every 100-150 Hours
Inspect for worn or damaged parts.	•				
Check for excessive vibration		•			
Inspect Impeller for cracks or damage					•
Inspect for loose parts.		•			

IMPELLER REMOVAL

1. Wait for engine to cool and disconnect spark plug.
2. Remove housing front cover, by removing (10) screws, around outside of front cover and the exhaust knob (22) and nut(14).
3. Remove impeller bolt (item #29), lock washer (item #7) and washer (item #28).
4. DO NOT pry on impeller. Pull on center hub area only of impeller. If impeller slides off freely, proceed to (step 6).
5. If the impeller does not loosen, obtain a 3/4-16x3" (Billy Goat part #440192) or longer bolt. Thread bolt by hand into nut until bolt rests against the shaft. Tighten the bolt slowly, which will pull the impeller away from the shaft, remove impeller from shaft. *Using a penetrating oil can help loosen a stuck impeller.*
6. Reinstall new impeller in reverse order of removal.
7. Tighten impeller bolt. Torque impeller bolt (see parts list on page 15 for proper impeller bolt torque specifications).

TIRE AIR PRESSURE

Check at regular intervals and maintain.

Rear Tires - 20 Psi (137 kPa).

STORAGE

⚠ Never store engine indoors or in enclosed poorly ventilated areas with fuel in tank, where fuel fumes may reach an open flame, spark or pilot light, as on a furnace, water heater, clothes dryer or other gas appliance.

If engine is to be unused for 30 days or more, prepare as follows:

⚠ Remove all gasoline from carburetor and fuel tank to prevent gum deposits from forming on these parts and causing possible malfunction of engine. Drain fuel outdoors, into an approved container, away from open flame. Be sure engine is cool. Do not smoke. Run engine until fuel tank is empty and engine runs out of gasoline.

NOTE

Fuel stabilizer (such as Sta-Bil™) is an acceptable alternative for minimizing the formation of gum deposits during storage. Add stabilizer to gasoline in storage container or fuel tank. Follow stabilizer manufacturer's instructions to determine proper mix ratio. Run engine at least 10 minutes after adding stabilizer to allow it to reach carburetor.

TROUBLESHOOTING

Problem	Possible Cause	Solution
Abnormal vibration.	<ul style="list-style-type: none"> · Loose or out of balance impeller. · Debris in impeller. · Loose engine. 	<ul style="list-style-type: none"> · Check impeller and replace if required. · Clear debris with compressed air or a backpack blower (see below pictures).* · Check engine.
Engine will not start.	<ul style="list-style-type: none"> · Engine not in full choke position. · Out of gasoline or bad, old gasoline. · Spark Plug wire disconnected. · Gas valve off. · Dirty air cleaner. 	<ul style="list-style-type: none"> · Check choke position. · Check gasoline. · Connect spark plug wire. · Turn on gas valve. · Clean or replace air cleaner. Contact a qualified service person.
Engine is locked, will not pull over.	<ul style="list-style-type: none"> · Engine problem. 	<ul style="list-style-type: none"> · Contact an engine servicing dealer for engine problems.
Aim-N-Shoot™ lever sticking	<ul style="list-style-type: none"> · Debris stuck around cone · Cone adjustment knob too tight · Adaptor mount nut (item 43) too tight 	<ul style="list-style-type: none"> · Clean debris · Apply silicone based lubricant to pivot points · Loosen manual adjustment knob · Loosen nut

*Using compressed air, or a Backpack blower, you can loosen or free debris easily from the impeller and housing, which can cause wear and tear on the machine. You can manually remove debris by taking off the front housing. Note: Always disconnect the sparkplug when servicing.



When servicing engine refer to specific manufacturers engine owner's manual. Engine warranty is covered by the specific engine manufacturer. If your engine requires warranty or other repair work contact your local servicing engine dealer. When contacting a dealer for service it is a good idea to have your engine model number available for reference (See table page 3). If you cannot locate a servicing dealer in your area you can contact the manufacturers national service organization. To reach:

Subaru America: 800-277-6246

WARRANTY CLAIM PROCEDURE

Should a BILLY GOAT® machine fail due to a defect in material and/or workmanship, the owner should make a warranty claim as follows:

- The machine must be taken to the dealer from whom it was purchased or to an authorized Servicing BILLY GOAT Dealer.
- The owner must present the remaining half of the Warranty Registration Card, or, if this is not available, the invoice or receipt.
- The Warranty Claim will be completed by the authorized BILLY GOAT Dealer and submitted to their respective BILLY GOAT Distributor for their territory Attention: Service Manager. Any parts replaced under warranty must be tagged and retained for 90 days. The model number and serial number of the unit must be stated in the Warranty Claim.
- The distributor service manager will sign off on the claim and submit it to BILLY GOAT for consideration.
- The Technical Service Department at BILLY GOAT will study the claim and may request parts to be returned for examination. BILLY GOAT will notify their conclusions to the distributor service manager from whom the claim was received.
- The decision by the Technical Service Department at BILLY GOAT to approve or reject a Warranty Claim is final and binding.

For online product registration go to www.billygoat.com

ILLUSTRATED PARTS LIST

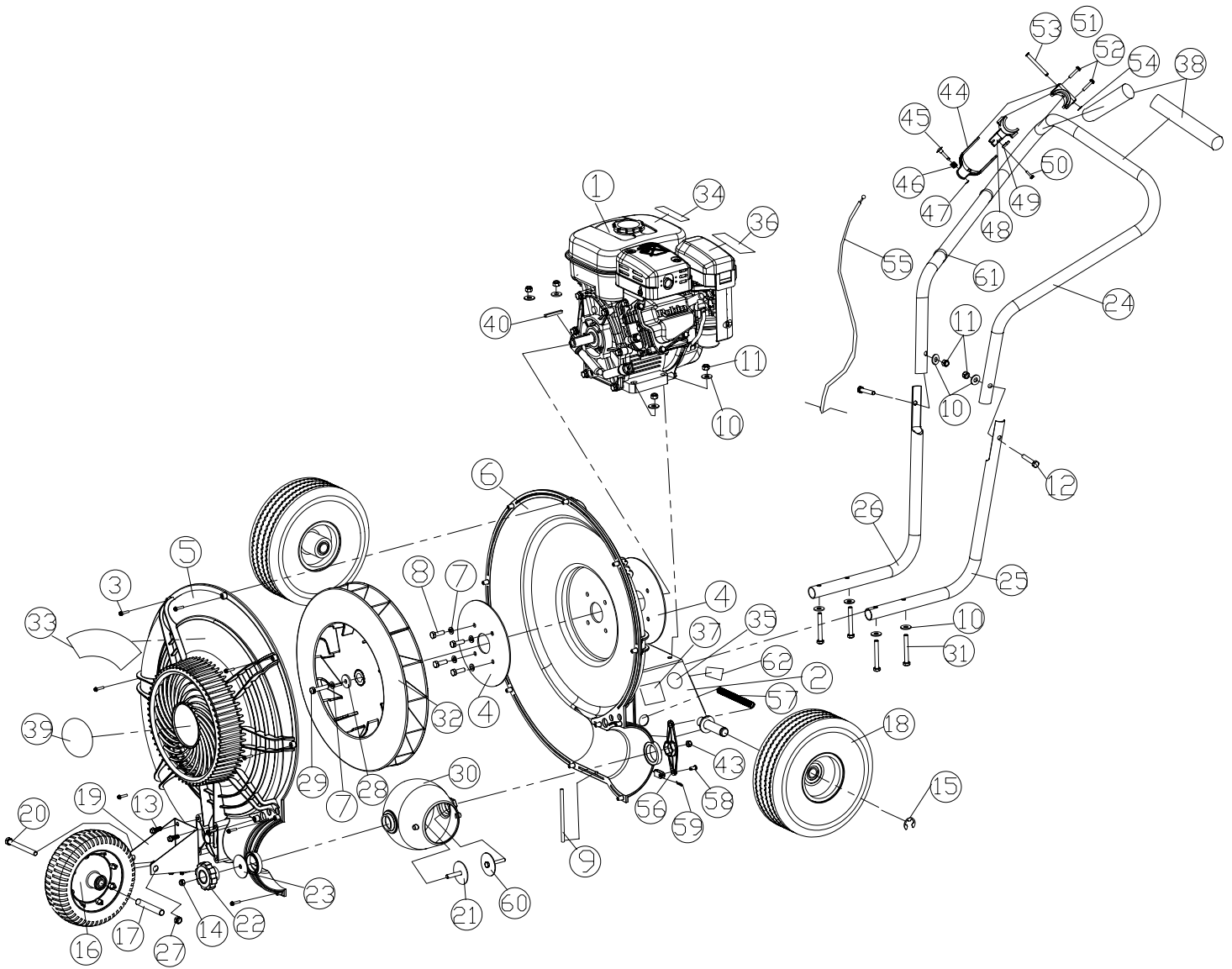



PARTS LIST

F601S			
ITEM NO.	DESCRIPTION	PART NUMBER	QTY.
	ENGINE 6 HP HORZ SUBARU	350307	1
2	BASE ENGINE WA	441151-S	1
3	SCREW PLASTITE #8-16 X 3/4" HWH	441155	10
4	PLATE REINFORCE HOUSING	441102	2
5	HOUSING FRONT MOLDED	441101-1-S	1
6	HOUSING BACK MOLDED	441101-2	1
7	WASHER LOCK 5/16 ST MED	8177011	5
8	SCREW CAP 3/8-16X1 1/2 ZP	400164	4
9	ROD HAND STOP	441154	1
10	WASHER 5/16 FLATWASHER Z/P	8171003	10
11	NYLON INSERT LOCKNUT 5/16-18	8160002	6
12	SCREWCAP 5/16-18 X 1.75 ZP	8041031	2
13	SCREW PLASTITE 1/4-10 X 3/4 HWH	840082	4
14	NUT LOCK 5/16-18 LT WT TH ZP	8161041	1
15	RING RETAINING 3/4	850230	2
16	WHEEL 8" X 0.5	441123	1
17	SPACER FRONT AXLE	441162	1
18	WHEEL ASSY 10"	400295	2
19	FRONT WHEEL BRACKET	441122	1
20	SCREWCAP 3/8-16 X 3 3/4 HCS ZP	8041061	1
21	WASHER W/BOLT WA	441156	1
22	KNOB 5/16-18 X 5/8 FLUTED	400339	1
23	WASHER EXTENSION	810652	1
24	HANDLE UPPER	441157-S	1
25	HANDLE LOWER LH	441158	1
26	HANDLE LOWER RH	441159	1
27	NUT LOCK 3/8-16 LT WT THIN ZP	8161042	1
28	WASHER 1.125 OD X 0.344 ID X 10 GA. (25 FT. L	441150	1
29	SCREWCAP 5/16-24 X 1 1/2 GR 8	830135	1
30	DIRECTOR CONE 3.5"	441120-01	1
31	SCREWCAP 5/16-18 X 2 1/2	8041034	4
32	IMPELLER ASSEMBLY 17"	441202-S	1
33	LABEL LOGO ARCH	441153	1
34	LABEL HOT ENGINE	400268	1
35	LABEL READ	890301	1
36	LABEL EAR EYE BREATHING	890254	1
37	LABEL DANGER FLYING DEBRIS	810736	1
38	GRIP 1" ID x 13"	400570	2
39	LABEL LOGO SMALL FRAME	441152	1
40	Key 3/16" SQ x 1 3/4	9201084	1
43	NUT LOCK 1/4"-20 HEX ZP	8160001	1
44	HANDLE DIVERTER FORCE	440119	1
45	PIN LATCH DIVERTER	440118	1
46	SPRING COMPRESSION 0.281 X 0.88	440129	1
47	RING RETAINING .122 DIA	440125	1
48	SADDLE UPPER DIVERTER	440115	1
49	PLATE LOCK DIVERTER	440116	1
50	SCREW PLASTITE #6-19 X 5/8"	440132	2
51	SADDLE LOWER DIVERTER	440114	1
52	SCREW PLASTITE #10-14 X 1"	440126	2
53	PIN PIVOT DIVERTER CONTROL	440123	1
54	RING RETAINING 5/16	430327	1
55	CABLE ASSY	441163	1
56	DIVERTER PIVOT ADAPTOR	440121	1
57	SPRING EXTENSION 0.375 X 3.75	440130	1
58	PIN CLEVIS 1/4 X 3/4	440124	1
59	.051 X 3/4" HITCH PIN CLIP	440193	1
60	ADAPTOR MOUNT WA	440122	1
61	TY-WRAP	900407	3
62	VIBRATION LABEL	440191	1

